

# INSTRUCTIONS

## **1. THE PRODUCT'S CHARACTERISTICS:**

The Product, oil-pressure wheel puller, made by the company through many years of research can serve its pulling force up to 12 tons. The product is available to pull any bearing, belt pulley, gear, round wheel or other tightened parts and accessories used in machinery of industry and family.

The product's greatest advantage is that its main shaft can go with any kind of wheel pulling claw, which will be in active operation, saves labor and portable, is our company's revolutionary brand-new product, in mass production to supply domestic industries.

## **2. DIRECTIONS:**

① First of all, be sure specifications of bearing, belt pulley, gear, round wheel or parts, then, lock it in the product's main shaft with proper wheel pulling claw required.

② Adjust the main shaft to center point of bearing, belt pulley, gear, round wheel or parts. Tightly turn it with hands, then, slowly turn T-handle clockwise which is at the head of main shaft. It will be portable and easy to have pressure to withdraw parts or accessories of machine.

③ In case the machine with longer parts or accessories, lengthening bar for main shaft is served in the product to connect with main shaft. It will smoothly withdraw every parts.

## **3. MAINTENANCE:**

After being used, the product should be maintained often to keep all accessories clean, get rid of dirt, spread lubricant and thoroughly wipe it, then, put it inside iron case.

Keep to check if the hydraulic oil inside main shaft is enough, operate it to test if its pushing force and extension meet to standards or if there is oil leakage happened. In case there is any defect mentioned above, turn bottle cover at the head of main shaft leftward to withdraw the bottle cover and examine it. Take out broken parts and replace new parts (the company supplies all kinds of parts), add hydraulic oil to seal and fix the bottle cover, then, use it.

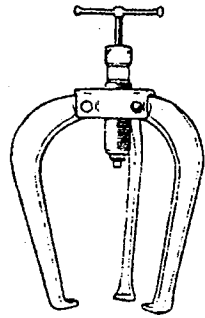

Three Jaws G4 8034  
G6 8036  
G8 8038

**CAPACITY:**

MAXIMUM 10T  
MINIMUM 7.5T

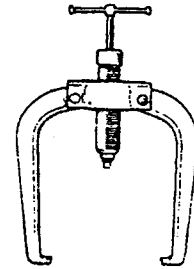



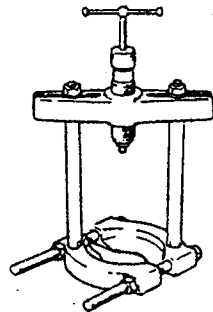







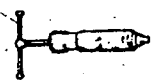

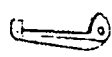
Two Jaws G4 8024  
G6 8026  
G8 8028

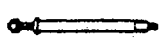

8066

**Hydraulic Gear Puller Parts**

**PARTS LIST OF INDIVIDUAL PULLERS & NUMBERS**

Part No.	Description		Part No.	Description		Part No.	Description	
8000	Hydraulic Ram (1" dia)		9013	Triple Head		9014	Beam	
8004	Leg 4" (100mm)		8014	Extension Rod(1"x2")		9015	Separator $\frac{3}{8}$ " - $4\frac{1}{4}$ " (20-105mm)	
8006	Leg 6" (150mm)		8015	Extension Rod(1"x4")		8002	Ram Ring	
8008	Leg 8" (200mm)		9016	Main Rod kpw pcs (2 pcs)		8011	Ram parts	
8012	Twin Head		8013	Sent Pcp (1" x $1\frac{1}{4}$ ")				

# INSTRUCTIONS

## 1. THE PRODUCT'S CHARACTERISTICS:

The product, oil-pressure wheel puller, made by our company through many years of research, can serve its pulling force up to 8 tons.

## 2. THE PRODUCT'S GREATEST ADVANTAGE:

- ① Its main shaft can go with any kind of wheel pulling claw, which will be active operation, save labor and portable.
- ② It is our company's revolutionary brand-new product, in mass production to supply industries all over the world.

## 3. DIRECTIONS OF THIS OIL—PRESSURE WHEEL PULLER:

- ① First of all, be sure specification of bearing, belt pulley, gear, round wheel or parts, then, choose the oil-pressure wheel puller with suitable specifications, such as 4" (100mm), 6" (150mm), 8" (200mm).
- ② Then, stretch the jaws, adjust the main shaft to center point of object. Tightly turn it with hands, then, slowly turn T-handle clockwise which is at the head of main shaft. It will be portable and easy to have pressure to withdraw parts or accessories of machine.
- ③ In case the machine with longer parts or accessories, lengthening bar for main shaft is served in the product to connect with main shaft. It will smoothly withdraw every parts.

## 4. MAINTENCE AND INSTRUCTIONS:

- ① First of all, open the box to check if all parts are available, then, fetch the hydraulic ram, please use your left hand to take ram and use your fingers of right hand to turn slowly in order to check if the ram ring is stretched out.  
If ram ring is stretched out about 1/2 inch (15mm), means ram ring is normal and useful.  
But if the length which ram ring stretch out is not enough or ram ring can not stretch out, means the oil for oil-seal of ram is not enough, then we shall maintenance it according to the following steps.
- ② Steps of maintenance when oil for oil-seal of ram is not enough:
  - a. First, turn the T-handle (1) left to fetch out, make terminal of ram contact with atmospheric pressure outside, form balance between the pressure inside and outside the ram. Please refer to drawing 1.
  - b. Then, use circular clip to clip circular part of ram cover (2) which is on the side of cover, turn cover (2) in order to make screw backward, then fetch out ram cover (2) and take ram ring (3) and spring (4) in order. Please refer to drawing 2.
  - c. Then, fetch out plastic seal (5), now you must take care that you have to take plastic seal (5) according to the following method slowly: The method is to extend T-type screw handle (6) from side of ram, in order to make T-type screw handle (6) parallel with ram and turn into plastic seal (5) straightly about 2mm depth (the depth can't be too long in order to prevent from damage of plastic seal (5) ), then pull out T-type screw handle (6) parallel with ram, fetch out plastic seal (5) from ram slowly, now you must prevent damage of plastic seal (5). Then, spread greasy lubricating oil (bearing oil) around ram. You just have to spread 0,020 kg bearing oil only.
  - d. After you have spreaded bearing oil around ram, you must check if the directions of plastic seal (5) and plastic seal (7) are right before assembly, that is, grooves of plastic seal (5) and plastic seal (7) are opposite. Please refer to drawing 1, check if groove of plastic seal (5) toward inside before assembly, that make plastic seal (5) with better oil-seal function.

Sometimes lack of oil or oil leak out occur, it is not during to damage of hydraulic gear puller, it's because changable weather, for example, bearing oil will melt when temperature is very high. So if you find bearing oil is not enough, you just only have to add some bearing oil, then you can go on using. Please don't have to worry about it. If bearing oil is enough, hydraulic gear puller can work forever.

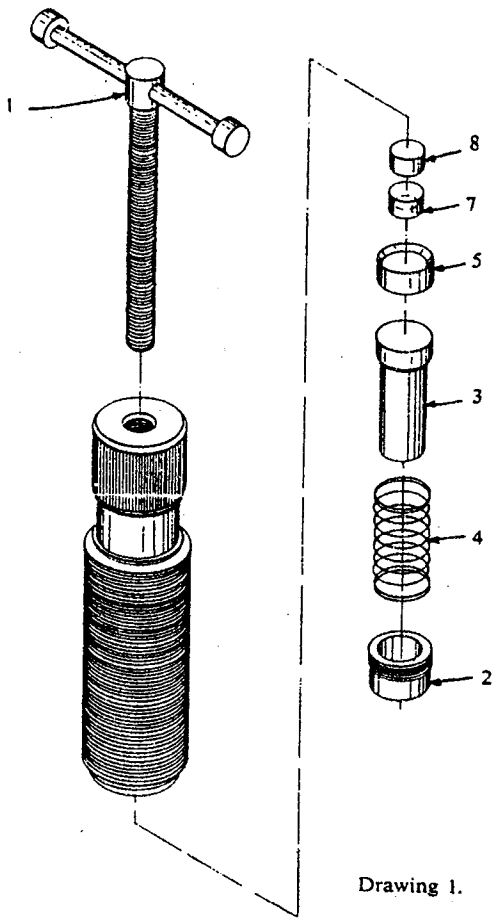

No.	Part Name
1	T-handle
2	Ram cover
3	Ram ring
4	Spring
5	Plastic seal
6	T-type screw handle
7	Plastic seal
8	Ram ring

Drawing 1.

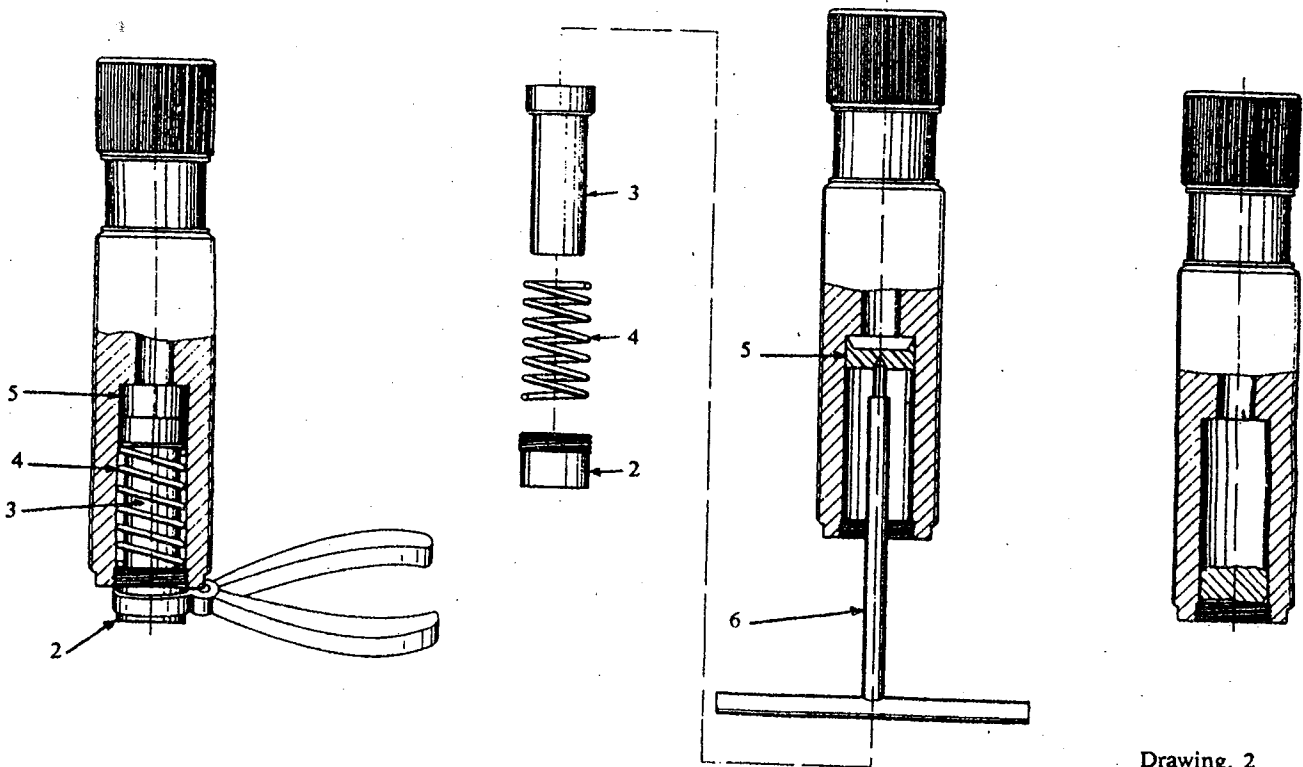

Drawing. 2